

OPERATING MANUAL SMOKE SENSOR FGSD-002-EN-A-v1.01

The Fibaro Smoke Sensor is a universal, optical Z-Wave smoke detector. Fire alarm is signaled by sound, visual indicator blinking and by sending Z-Wave alarm and control commands.

The optical sensor detects smoke at an early stage of fire, often before flames appear and temperature starts to rise significantly. Moreover the device has a built-in temperature sensor, which is programmable indicator of exceeding set temperature level.

The Fibaro Smoke Sensor is designed to be placed on a wall or ceiling. Visual indicator signals fire, operating mode and is used to see if device is within the Z-Wave network. The smoke sensor is designed to operate in confined spaces, under normal conditions (lacking smoke, dust, condensed water vapor).

SPECIFICATIONS

Battery Type:	CR123A
Compliance with:	EN 14604:2005 RoHS 2011/65/EU R&TE 1999/5/EC
Radio protocol:	Z-Wave
Radio frequency:	868,4 or 869,8 MHz EU; 908,4 or 916 MHz US; 921,4 or 919,8 MHz ANZ; 869 MHz RU;
Range:	up to 50m outdoors up to 30m indoors (depending on terrain and building structure)
Operational Temperature:	0°C - 55°C
Operational Humidity:	0% - 93%
Measured Temperature Range:	-20°C to 100°C
Temperature Measuring Accuracy:	0,5°C (within 0°C - 55°C range)
Dimensions (Diameter x Height):	65 x 28 mm

TECHNICAL INFORMATION

- Compatible with any Z-Wave or Z-Wave+ Controllor
- Supports protected mode (Z-Wave network security mode) with AES-128 encryption
- Extremely easy installation - simply install it in location prone to fire.
- Battery powered
- 3 levels of sensors sensitivity
- Built-in casing opening detector
- Alarm is signaled by sound, visual indicator and Z-Wave control command
- Programmable excess temperature warning
- Automatic test performed every 10 seconds



CAUTION

Read this manual before attempting to install the device. Failure to observe recommendations included in this manual may be dangerous or cause a violation of the law. The manufacturer, Fibar Group Sp. z o.o., will not be held responsible for any loss or damage resulting from not following the instructions of operating manual.



CAUTION

Work within local code height requirements during installation of the Fibaro Smoke Sensor. Take special precautions during installation and use tools and equipment in perfect working order. It's recommended to observe ladders, lifts and other obstacles.



CAUTION

Maintenance inspections should be performed regularly. Manufacturer recommends the functional and visual checks to be performed at least once a week. Functional check includes self-test (see p. VI).



CAUTION

When handled carelessly or used in non-specified environment conditions, the device may not function properly. It's highly recommended to take all safety precautions to ensure safety and property protection.



CAUTION

Depending on the Smoke Sensors internal conditions (e.g. battery discharge, device failure, etc.) and ambient conditions, fire alarms are not always effective in all situations. Smoke Sensors must be tested regularly according to this operating manual and local code. Ventilation systems, chimneys and potentially dangerous devices that can cause a fire should be regularly inspected as well.

There are various situations against which the fire alarm may not be effective, for example:

- 1) Fires where the victim is intimate with a flaming initiated fire; for example, when a person's clothes catch fire while cooking;
- 2) Fires where the smoke is prevented from reaching the detector due to a closed door or other obstruction;
- 3) Incendiary fires where the fire grows so rapidly that an occupant's egress is blocked even with properly located detectors.



CAUTION

Current studies show that fire alarms may not awake all sleeping individuals and that it is the responsibility of other residents to assist those who may not be awakened by the alarm sound or those who may be incapable of safely leaving the area unassisted.



NOTE

The Fibaro Smoke Sensor is a Security Enabled Z-Wave Plus product and a Security Enabled Z-Wave Controller must be used in order to fully utilize the product.

GLOSSARY OF TERMS

- **adding** - Z-Wave device learning mode, allowing to add the device to existing Z-Wave network.
- **removing** - Z-Wave device learning mode, allowing to remove the device from existing Z-Wave network.
- **association** (linking devices) - direct control of other devices within the Z-Wave system network.
- **multi-channel association** - controlling other multi-channel devices within the Z-Wave network.
- **control command** - type of Z-Wave network command enforcing change of device state.
- **report command** - type of Z-Wave network command holding an additional information, e.g. alarm state or measured temperature.
- **alarm command** - type of Z-Wave network command holding a warning of danger occurrence, e.g. fire alarm.
- **multi-channel device** - device having multiple endpoints - various device functions.

I. ADDING TO Z-WAVE NETWORK

Fibaro Smoke Sensor inclusion:

- 1) Install the battery. Visual indicator will signal the Z-Wave network inclusion status (red - device ready for inclusion, green - device included, remove firstly - see p. II).
- 2) Make sure the device is located within direct range of the Z-Wave controller.
- 3) Set the main controller into the learning mode (see main controller's operating manual).
- 4) Quickly, triple click the B-button, located on Fibaro Smoke Sensor's casing.
- 5) Fibaro Smoke Sensor will be detected and included in the Z-Wave network.

II. REMOVING FROM Z-WAVE NETWORK

- 1) Make sure the sensor is connected to battery.
- 2) Set the main controller into the learning mode (see main controller's operating manual)
- 3) Quickly, triple click the B-button, located on Fibaro Smoke Sensor's casing.

III. SENSOR INSTALLATION



NOTE

It's recommended to install the sensor on the ceiling or upper portion of wall at least 40cm (2 feet) from corners and other objects. Particular attention should be paid to any adjacent objects or devices which can impede smoke's access to the sensor. It's recommended to install Fibaro Smoke Sensor in all rooms prone to fire, and in between such rooms as well.

Installing Fibaro Smoke Sensor:

- 1) Include the device into the Z-Wave network (see p. I). Note the inclusion process may be performed ONLY in direct range of the main controller.
- 2) Install the sensor's cover in desired location.
- 3) Screw the Fibaro Smoke Sensor into the cover.
- 4) If the sensor is already included into the Z-Wave network, wake it up by clicking the B-button. Otherwise, add the device as described in p. I.
- 5) Test Fibaro Smoke Sensor's operation by performing a self-test - press & hold the B-button (see p.VI)
- 6) Test the Z-Wave network range (see p.XIV) assuring the device is within range.

INSTALLATION NOTES:

- 1) When choosing location of smoke sensor, make sure the alarm sound can be easily audible in other rooms in the building.
- 2) It's recommended to install the sensor in already decorated, painted rooms.
- 3) It's recommended to install the sensor at least 1,5m from air conditioners.
- 4) Do not install the sensor in direct sunlight. Keep at least 0,5m distance from light sources.
- 5) Do not install the sensor in places prone to drafts.
- 6) Do not install the sensor in places with high water vapor condensation, e.g. above stoves, ovens, kettles, etc.
- 7) The device can not be installed in places where the temperature exceeds operational values (0°C - 55°C).

BATTERY TIPS

Fibaro Smoke Sensor's battery life is at least equal to two years.

The wake-up interval is recommended to be set at a default value (6 hours). In case of choosing a smaller value, the lifetime of a battery can decrease significantly.



The current battery level is displayed in the Z-Wave controller's interface, e.g. Home Center 2 or Home Center Lite. Red battery icon means that battery needs replacement. In addition, the device itself, apart from the main controller, monitors the battery level and a low battery is signaled with a yellow blinking visual indicator and an intermittent sound alarm. The Fibaro Smoke Sensor reports low battery level for at least 30 days until it is completely discharged.

BATTERY REPLACEMENT PROCEDURE:

Once a Fibaro Smoke Sensor has reported low battery level or battery is discharged, it should be replaced observing the following procedure:

- 1) Detach the sensor from its cover by turning the device counter-clockwise.
- 2) Remove the flat battery from the device. Then press and hold the B-button for 3 seconds.
- 3) Insert a new CR123A battery observing the polarities shown inside. Visual indicator will signal Z-Wave network inclusion status (green - device included, red - device not included).
- 4) Test Fibaro Smoke Sensor's operation by performing a self-test (see p. VI).
- 5) Attach the device into the cover by turning clockwise.



CAUTION

Fibaro Smoke Sensor is equipped with dedicated safety mechanism (Fig. 2, Fig. 3) which prevents closing the casing without installed battery.



CAUTION

It's strongly recommended to perform the self-test after each battery replacement to ensure correct device operation.

IV. FIRE DETECTION

Fibaro Smoke Sensor responds to the physical presence of smoke. Smoke presence is required for the device to react. Fibaro Smoke Sensor every 10 seconds checks for smoke presence. Once the level of smoke exceeds value set in parameter 1, Fibaro Smoke Sensor triggers an alarm.

Fire alarm is signaled by sending an appropriate alarm command to devices, the Z-Wave controller and also by an intermittent sound and visual indicator blinking red. Once the fire alarm has ceased, the sensor checks whether the smoke has actually disappeared before getting back to normal operation, i.e. performing a self test each 10 seconds and checking for presence of smoke.



NOTE

As described in section IV, the Fibaro Smoke Sensor checks for smoke presence every 10 seconds. In addition, the device checks for malfunction and tests the Z-Wave network communication (see section VII) at each wake up interval (6 hours by default) and when sending reports, provided that range test has been enabled in advanced configuration.



CAUTION

Fibaro Smoke Sensor is a multiple use device, however, for greater safety, it's recommended to replace the device with a new one after a fire occurrence.



CAUTION

If fire alarm is triggered, but the level of smoke did not exceed concentration equal to three times of the sensitivity set in parameter 1 (the individual levels of sensitivity are printed on the device casing), user can mute sound alarm by holding the B-button (temporarily reducing the sensor's sensitivity). Visual indicator will still indicate an alarm state by blinking red. If smoke level concentration is greater than three times of the sensitivity set in parameter 1, mute will automatically turn off and the device will alarm fire again (using visual and audible indicator).

V. PROGRAMMABLE EXCESS TEMPERATURE WARNING

Apart from detecting presence of smoke, Fibaro Smoke Sensor has an additional function of informing of exceeding the programmed temperature threshold. The function is disabled by default in parameter 2 settings. Excess temperature warning is defined by user in parameter 30 - set to 55°C by default. Excess temperature level can be also signaled by visual indicator glow (parameter 3) and short beep (parameter 4). Parameter 20 should not be set to 0 because such setting disables temperature measurements.

VI. MALFUNCTION DETECTION

The Fibaro Smoke Sensor can automatically detect a malfunction. As described in section IV, the device performs a test every 10 seconds. If malfunction is detected (e.g. damaged smoke chamber) an intermittent sound signal will start and alarm will be sent to the Z-Wave network controller.

Once trouble alarm has been detected, it's recommended to dismount the sensor and:

- check the power source (replace battery),
- check whether the Smoke Sensor is exposed to direct light.

If a trouble alarm is continually reported, it's recommended to replace Fibaro Smoke Sensor with new one or contact with guarantor if the product warranty is still valid.

Self-test may be triggered manually:

- 1) Make sure the device is powered by the battery
 - 2) Press and hold the B-button. The visual indicator will glow white and the short alarm will sound. Keep holding the B-button. After 3 seconds from the first beep smoke chamber operation will be checked.
- Triggering fire alarm and beep mean positive result and should occur within 10 seconds. No fire alarm means that the sensor is malfunctioning.



CAUTION

When the self-test is triggered manually the Fibaro Smoke Sensor sends control command to the Z-Wave network controller. The procedure will be performed at least as long as the B-button is not released (will be completed in up to 10 seconds after releasing B-button).



CAUTION

Any service or repair must be carried out by the manufacturer. The expiry date of the device is indicated on its back.

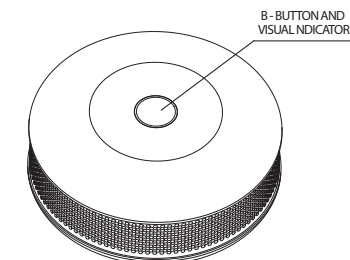

Fig. 1 - Fibaro Smoke Sensor top view

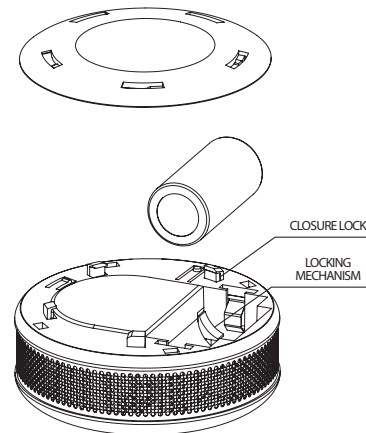

Fig. 2 - Fibaro Smoke Sensor bottom view without the battery installed

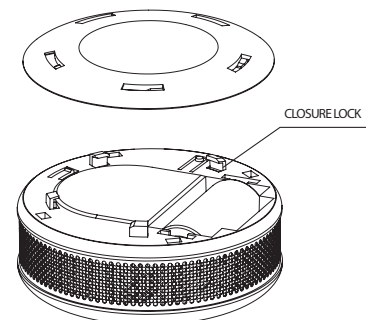

Fig. 3 - Fibaro Smoke Sensor bottom view with the battery installed

VII. DETECTING LACK OF Z-WAVE RANGE

When included in the Z-Wave network, Fibaro Smoke Sensor tests the network communication. By default the procedure is performed at each temperature report depending on parameters 20 and 21 settings. In addition, Z-Wave network communication test is performed during waking up. Lack of the Z-Wave network communication may be signaled by an intermittent alarm sound and visual indicator blinking violet. By default sound and visual signals are disabled but you can enable it by changing values of parameters 3 and 4 (section XVI).

Once a Fibaro Smoke Sensor has reported no Z-Wave network communication, it's recommended to wake up the device by clicking the B-button. If it doesn't stop the alarm, Z-Wave networks operation and the main controllers operation need to be verified.

The Fibaro Smoke Sensor will cancel the Z-Wave network communication alarm once it communicates with the network after manual or automatic wake up.

VIII. SENSOR'S SENSITIVITY LEVEL CONFIGURATION

Optical smoke detector used in the Fibaro Smoke Sensor has 3 levels of sensitivity, compliant with EN 14604:2005. By default, the detector is set to the middle sensitivity level. Sensitivity level depends on the parameter 1 settings (modified only through the main Z-Wave controller).

IX. RESETTING THE FIBARO SMOKE SENSOR

Resetting the Fibaro Smoke Sensor erases the device memory, including all information on the Z-Wave network and the main controller.

Fibaro Smoke Sensor reset procedure:

- 1) Make sure the device has the battery installed.
- 2) Press and hold the B-button for 3 seconds until visual indicator glows white.
- 3) Short signal will sound.
- 4) Release the B-button.
- 5) Wait until the visual indicator glows yellow, signaling entering the 4th menu option.
- 6) Press the B-button briefly to confirm your choice.

Successful reset will be confirmed with the visual indicator changing colour to red and fading. At the same time, short beep will sound, same as at the power connection.

Please use this procedure only in the event that the system primary controller is missing or otherwise inoperable.



CAUTION

Reset procedure should remove Fibaro Smoke Sensor from the Z-Wave network main controller's memory (depending on the controller's version). Removing the device from the Z-Wave network will reset Fibaro Smoke Sensor automatically.

X. OPERATING THROUGH THE Z-WAVE NETWORK

Fibaro Smoke Sensor has a built in smoke detector and a temperature sensor, which makes it a multi channel device. In the Home Center interface it will be presented as two devices, depending on the main controller software version:



Fig. 4 Smoke Sensor icon in Fibaro Home Center

Fig. 5 Smoke Sensor icon in Fibaro Home Center indicating the fire alarm

Fig. 6 Temperature Sensor icon in Fibaro Home Center

Fibaro Smoke Sensor ignores incoming BASIC SET command and returns the status of alarm on BASIC GET command at the moment of wake up. (0 - no alarm, 255 - alarm active).

XI. ASSOCIATIONS

Through an association Fibaro Smoke Sensor may control another Z-Wave network device, e.g. a Dimmer, Relay Switch, Roller Shutter, RGBW Controller, Wall Plug, or a scene (scene only through the main controller).



CAUTION

Association allows for direct communication between Z-Wave network devices. Main controller does not take part in such communication. Using this mechanism, Fibaro Smoke Sensor may communicate with other devices even when the main controller is damaged, e.g. in a fire.

Fibaro Smoke Sensor allows for the associations of five groups.

- 1st group – **Lifeline**. Reporting device state. Only one device - Z-Wave network controller may be set in this group. It's not recommended to modify this association group.
- 2nd group – **Smoke Alarm**. Sending the BASIC SET control command once smoke is detected. Its value may be modified in advanced parameters (see section XVI). Group may control up to five on/off devices.
- 3rd group – **Tamper**. Sending the notification NOTIFICATION REPORT (TYPE = BURGLAR, EVENT = PRODUCT COVERING REMOVED) to associated devices once casing opening is detected. Up to five devices supporting casing opening command (NOTIFICATION REPORT) may be included in this group.
- 4th group – **Smoke Alarm**. Sending the notification SENSOR ALARM REPORT (TYPE = SMOKE ALARM) to associated devices once smoke is detected. Up to five devices supporting SMOKE ALARM command may be included in this group.
- 5th group – **Tamper**. Sending the SENSOR ALARM REPORT notification (TYPE = GENERAL) to associated devices once casing opening is detected. Up to five devices supporting SENSOR ALARM REPORT command may be included in this group.

Fibaro Smoke Sensor allows for controlling 5 regular or 5 multichannel devices per an association group in groups 2-5 and one device in the 1st group.

To add an association (using Home Center interface) go to device settings and

click the following icon: 

Select the "Advanced" tab and specify to which group and what devices are to be associated. Sending relevant information configuring associations of the device may take up to a few hours depending on the previous configuration parameters settings. Wake up the device manually to speed up the configuration process.

XII. MENU MODE AND VISUAL INDICATIONS

The Fibaro Smoke Sensor is equipped with visual indicator for indicating and signaling sensor's operating modes and alarms. In addition the visual indicator may inform of the Z-Wave network range or exceeded temperature threshold.

Visual indicator modes:

- 1) Alarms indications (see p. XIII)
- 2) Added device status is signaled by a single green blink while inserting the battery.
- 3) Removed device status is signaled by a single red blink while inserting the battery.
- 4) Software update procedure is signaled by blinking in cyan
- 5) Successful software update is signaled with glowing in green
- 6) Unsuccessful software update is signaled with glowing in red
- 7) MENU levels are signaled with glowing in certain colour.

To enter MENU, press and hold the B-button for 3 seconds. Once the indicator glows white, release the B-button. Visual indicator will then start changing colours in sequence. Each colour means different MENU level. Transitions between the MENU levels will be signaled with a short beep as well. Press the B-button briefly to confirm choice.

Visual indicator colours will change in the following sequence:

- WHITE** - entering MENU + software update procedure,
- GREEN** - sending device state to associated devices,
- VIOLET** - Z-Wave range test,
- YELLOW** - device reset.

XIII. ALARMS AND NOTIFICATIONS

The Fibaro Smoke Sensor indicates particular states as follows:

- **Fire alarm** - three short beeps and visual indicator blinking red every 1,5 seconds (high priority)
- **Low battery alarm** - short beep and visual indicator blinking yellow once per 50 seconds (normal priority)
- **Trouble alarm** - short beep once per 50 seconds (normal priority)
- **Exceeding temperature threshold** - short beep and visual indicator blinking blue once per specified time interval (parameter 31 - 10 seconds by default) (low priority)
- **Lack of Z-Wave range** - short beep and visual indicator blinking violet diode once per specified time interval (parameter 32 - 30 minutes by default) (low priority)
- **Opened casing detection** - short beep and visual indicator blinking white

- Except Fire, Low battery and Trouble alarm, the other notifications are by default disabled.
- If more than one alarm is triggered, the alarm with the highest priority is signaled.
- Fibaro Smoke Sensor automatically cancels fire alarms sent to the main Z-Wave network main controller and associated devices as well.
- The casing opening notification cannot be cancelled through MENU.

XIV. Z-WAVE RANGE TEST

The Fibaro Smoke Sensor has a built in Z-Wave network main controller's range tester. Follow the below instructions to test the main controller's range:

- 1) Make sure the sensor is powered.
- 2) Press and hold the B-button for 3 seconds. Visual indicator will glow white.
- 3) Short signal will sound.
- 4) Release the B-button.
- 5) Wait until the visual indicator glows violet, and then press the B-button briefly to start the test.
- 6) Visual indicator will indicate the Z-Wave network's range (range signaling modes described below).
- 7) To exit Z-Wave range test, press the B-button briefly.

Z-Wave range tester signaling modes:

Visual indicator pulsing green - Fibaro Smoke Sensor attempts to establish a direct communication with the main controller. If a direct communication attempt fails, sensor will try to establish a routed communication, through other modules, which will be signaled by visual indicator pulsing yellow.

Visual indicator glowing green - Fibaro Smoke Sensor communicates with the main controller directly.

Visual indicator pulsing yellow - Fibaro Smoke Sensor tries to establish a routed communication with the main controller through other modules.

Visual indicator glowing yellow - Fibaro Smoke Sensor communicates with the main controller through the other modules. After 2 seconds the sensor will retry to establish a direct communication with the main controller, which will be signaled with blinking in green.

Visual indicator pulsing violet - Fibaro Smoke Sensor communicates at the range limit. If connection proves successful it will be confirmed with a yellow glow. It's not recommended to use the sensor at the range limit.

Visual indicator glowing red - Fibaro Smoke Sensor is not able to connect to the main controller directly or through another Z-Wave network nodes.

 **CAUTION**
During the Z-Wave network range test, Fibaro Smoke Sensor is not detecting fire. Device resumes previous operation mode once the Z-Wave network range rest has been finished. Z-Wave range test may be enabled only by user.

XV. SOFTWARE UPDATE

The Fibaro Smoke Sensor features remote software update. Complete the following steps to perform device update:

- 1) Detach the sensor from its cover by turning the device counter-clockwise.
- 2) Make sure the device is located within direct range of the Z-Wave network controller.
- 3) Set the main controller into update mode (see controller's manual)
- 4) Press and hold the B-button for 3 seconds. Visual indicator will glow white. Short signal will sound.
- 5) Release the B-button.
- 6) Press the B-button briefly to confirm menu level choice (white visual indicator). Update process will be signaled be the visual indicator blinking cyan. The update process may take up to 10 minutes. During the update process, please do not remove the battery.
- 7) Successful update will be confirmed with the visual indicator changing colour to red. Incorrect update process is indicated by the visual indicator changing colour to green, regardless of the reason.
- 8) After the software update, self-test should be performed manually (see p. VI) to make sure the device is working properly.

 **CAUTION**
Update procedure needs to be performed twice in order to update the device completely.

 **CAUTION**
If update fails or update time exceeds 10 minutes, please remove the battery, press and hold the B-button for 3 seconds, install the battery again and repeat an update procedure. If that does not work please contact our tech support team.

 **CAUTION**
Controllers from various manufacturers can have different ways of activating the software update procedure (see controller's manual).

 **CAUTION**
If the sensor has not completed the self-test successfully after the software update, please try to perform the test again. After two consecutive self-test attempts has failed, Fibaro Smoke Sensor is considered to be faulty and should be subject to service procedure.

 **CAUTION**
Software update may be enabled only by user. During the update Fibaro Smoke Sensor does not detect fire. Once the software update is completed the device resumes normal operation.

 **NOTE**
Update will not be performed if battery level is low.

 **NOTE**
If parameter 2 value responsible for activation of casing opening notification has been set to active mode, please consider deactivating it for the upgrade procedure duration.

XVI. ADVANCED CONFIGURATION

WAKE UP INTERVAL: (3 bytes)

Available settings: **0, 4200 - 65535** (4200s – 65535s)

Default setting: **21600** (21600s = 6h)

Wake up interval is specified in seconds. At each wake up Smoke Sensor communicates with the main controller, updates parameters settings and the software if necessary. The Smoke Sensor will wake up at defined time interval and will ALWAYS try to communicate with the main controller. After each failed communication attempt, the sensor will retry to establish connection with the main controller after 60 seconds. After 3 failed attempts, the lack of the Z-Wave range alarm will be triggered. Longer time interval means less frequent communication and thus a longer battery life. The Z-Wave range alarm will be cancelled automatically, after first successful connection. Change of wake up interval value does not affect alarms or trouble signals operation.

 **CAUTION**
Setting to 0 disables sending Wake Up Notification frame. Wake up may be still performed manually by a single B-button click or by sending Node Info frame (triple click the B-button).

1. Fibaro Smoke Sensor sensitivity

There are 3 levels of sensitivity to smoke presence. Level 1 means the highest sensitivity. Raising the parameter value lowers the sensitivity to smoke presence.

Available settings: **1 - 3**

- 1 - HIGH Sensitivity
- 2 - MEDIUM Sensitivity
- 3 - LOW Sensitivity

Default setting: **2**

Parameter size: **1** [byte]

2. Z-Wave notifications status

This parameter allows to activate excess temperature and/or casing opening notifications sent to the main controller.

Available settings: **0 - 3**

- 0 - all notifications disabled
- 1 - casing opening notification enabled
- 2 - exceeding temperature threshold notification enabled

Default setting: **0** (notifications disabled)

Parameter size: **1** [byte]

Parameter values may be combined, e.g. 1+2=3, means that all notifications are enabled.

3. Visual indicator notifications status

This parameter allows to activate visual indications but does not apply to major alarms, such as Fire, Trouble and Low battery alarm.

Available settings: **0 - 7**

- 0 - all notifications disabled
- 1 - casing opening notification enabled
- 2 - exceeding temperature threshold notification enabled
- 4 - lack of Z-Wave range notification

Default setting: **0** (notifications disabled)

Parameter size: **1** [byte]

Parameter values may be combined, e.g. 1+2+4=7, means that all notifications are enabled.

4. Sound notifications status

This parameter allows to activate sound signals but does not apply to major alarms, such as Fire, Trouble and Low battery alarm.

Available settings: **0 - 7**

- 0 - all notifications disabled
- 1 - casing opening notification enabled
- 2 - exceeding temperature threshold notification enabled
- 4 - lack of Z-Wave range notification

Default setting: **0** (notifications disabled)

Parameter size: **1** [byte]

Parameter values may be combined, e.g. 1+2+4=7, means that all notifications are enabled.

10. Configuration of control frames in BASIC command class

This parameter defines which frames will be sent in the 2-nd Association Group (SMOKE ALARM). The values of BASIC ON and BASIC OFF frames may be defined as described in further parameters.

Available settings: **0 - 2**

- 0 - BASIC ON & BASIC OFF enabled

1 - BASIC ON enabled

2 - BASIC OFF enabled

Default setting: **0** (both frames enabled)

Parameter size: **1** [byte]

11. BASIC ON frame value

BASIC ON frame is sent in case of smoke presence detection and Fire Alarm triggering. Its value is defined by the parameter.

Available settings: **0-99, 255**

0 - turn off the device

1-99 - set the device to 1-99%

255 - set the last status

Default setting: **255**

Parameter size: **2** [bytes]

12. BASIC OFF frame value

BASIC OFF frame is sent in case of Fire Alarm cancellation. Its value is defined by the parameter.

Available settings: **0-99, 255**

0 - turn off the device

1-99 - set the device to 1-99%

255 - set the last status

Default setting: **0** (turn off the device)

Parameter size: **2** [bytes]

13. Alarm broadcast

A value other than 0 means that alarms are being sent in broadcast mode, i.e. to all devices within a Fibaro Smoke Sensor's range.

Available settings: **0 - 3**

0 – broadcast inactive

1 – SMOKE ALARM command broadcast (2-nd & 4-th Association Group) active;

casing opening notification broadcast (3-rd & 5-th Association Group) inactive

2 – SMOKE ALARM command broadcast (2-nd & 4-th Association Group) inactive;

casing opening notification broadcast (3-rd & 5-th Association Group) active

3 – SMOKE ALARM command broadcast (2-nd & 4-th Association Group) active;

casing opening notification broadcast (3-rd & 5-th Association Group) active.

Default setting: **0** (broadcast inactive)

Parameter size: **1** [byte]

 **NOTE**
Operating in Z-Wave network security mode automatically disables sending alarms in broadcast mode.

14. Associations in Z-Wave network security mode

This parameter defines how commands are sent in specified association groups: as secure or non-secure. Parameter is active only in Z-Wave network security mode. It doesn't apply to 1st Lifeline group.

Available settings: **0 - 15**

0 - all groups sent as non-secure

1 - 2nd group sent as secure

2 - 3rd group sent as secure

4 - 4th group sent as secure

8 - 5th group sent as secure

Parameter values may be combined, e.g. 1+2=3 means that 2nd & 3rd group are sent as secure.

Default setting: **15** (all groups sent as secure)

Parameter size: **1** [byte]

20. Temperature report interval

Time interval between consecutive temperature reports.

Report is sent when new temperature value is different from the one previously reported - according to the set hysteresis (parameter 21). Temperature reports can be also sent as a result of polling.

Available settings: **0, 1-8640** (multiply by 10 seconds) [10s-24h]

0 – reports inactive

1-8640 - [10s-24h]

Default setting: **1** (10 seconds)

Parameter size: **2** [bytes]

21. Temperature report hysteresis

The temperature report will only be sent if there is a difference in temperature value from the previous value reported, defined in this parameter (hysteresis). Temperature reports can be also sent as a result of polling.

Available settings: **1 – 100** (in 0,1°C steps)

1-100 - (multiply by 0,1) [0,1°C - 10°C]

Default setting: **10** (1°C)

Parameter size: **1** [byte]

30. Temperature threshold

Temperature value measured by the built-in temperature sensor above which the excess temperature notification is sent (visual indication/sound/Z-Wave report).

Available settings: **1 - 100**

1-100 – (1°C - 100°C)

Default setting: **55** (55°C)

Parameter size: **1** [byte]

31. Excess temperature signaling interval

Time interval of signaling (visual indication/sound) excess temperature level

Available settings: **1-8640** (multiply by 10 seconds) [10s-24h]

1-8640 - [10s-24h]

Default setting: **1** (10 seconds)

Parameter size: **2** [bytes]

32. Lack of Z-Wave range indication interval

Time interval of signaling (visual indication/sound) lack of Z-Wave range

Available settings: **1-8640** (multiply by 10 seconds) [10s-24h]

1-8640 - [10s-24h]

Default setting: **180** (30min)

Parameter size: **2** [bytes]

 **CAUTION**
Parameters 30, 31 and 32 are associated with parameters 2, 3 and 4 settings. Their modification may have no effect if configured functionality is not activated in the corresponding parameter.

 **CAUTION**
Default values of advanced parameters may be changed only if the device is added to the main Z-Wave network controller.

XVII. BATTERY USE WARNING

Fibaro Smoke Sensor is a battery-powered device. Using batteries other than specified may result in explosion. Dispose of properly, observing environmental protection rules.

XVIII. GUARANTEE

1. The Guarantee is provided by FIBAR GROUP S.A. (hereinafter "Manufacturer"), based in Poznan, ul. Lotnicza 1; 60-421 Poznan, entered in the register of the National Court Register kept by the District Court in Poznań, VIII Economic Department of the National Court Register, no. 533265, NIP 7811858097, REGON: 301595664.

2. The Manufacturer is responsible for equipment malfunction resulting from physical defects (manufacturing or material) of the Device during 12 months for business / 24 months for individual customers from the date of its purchase.

3. During the Guarantee period, the Manufacturer shall remove any defects, free of charge, by repairing or replacing (at the sole discretion of the Manufacturer) any defective components of the Device with new or regenerated components that are free from defects. When the repair proves impossible, the Manufacturer reserves the right to replace the device with a new or regenerated one, which shall be free from any defects and its condition shall not be worse than the original device owned by the Customer.

4. In special cases, when the device cannot be replaced with the device of the same type (e.g. the device is no longer available), the Manufacturer may replace it with a different device having technical parameters similar to the faulty one. Such activity shall be considered as fulfilling the obligations of the Manufacturer. The Manufacturer shall not refund money paid for the device.

5. The holder of a valid guarantee shall submit a guarantee claim through the guarantee service. Remember: before you submit a guarantee claim, contact our technical support using telephone or e-mail. More than 50% of operational problems are resolved remotely, saving time and money spent to initiating guarantee procedure. If remote support is insufficient, the Customer shall fill the guarantee claim form (using our website - www.fibaro.com) in order to obtain claim authorization. When the guarantee claim form is submitted correctly, the Customer shall receive the claim confirmation with a unique number (Return Merchandise Authorization - RMA).

6. The claim may be also submitted by telephone. In this case, the call is recorded and the Customer shall be informed about it by a consultant before submitting the claim. Immediately after submitting the claim, the consultant shall provide the Customer with the claim number (RMA-number).

7. When the guarantee claim form is submitted correctly, a representative of the Authorised Guarantee Service (hereinafter as "AGS") shall contact the Customer.

8. Defects revealed within the guarantee period shall be removed not later than 30 days from the date of delivering the Device to AGS. The guarantee period shall be extended by the time in which the Device was kept by AGS.

9. A faulty device shall be provided by the Customer with complete standard equipment and documents proving its purchase.

10. Parts replaced under the guarantee are the property of the Manufacturer. The guarantee for all parts replaced in the guarantee process shall be equal to the guarantee period of the original device. The guarantee period of the replaced part shall not be extended.

11. Costs of delivering the faulty device shall be borne by the Customer. For unjustified service calls, the Service may charge the Customer with travel expenses and handling costs related to the case.

12. AGS shall not accept a complaint claim only when:

- the Device was misused or the manual was not observed,
- the Device was provided by the Customer incomplete, without accessories or nameplate,
- it was determined that the fault was caused by other reasons than a material or manufacturing defect of the Device
- the guarantee document is not valid or there is no proof of purchase,

13. The Manufacturer shall not be liable for damage to property caused by defective device. The Manufacturer shall not be liable for indirect, incidental, special, consequential or punitive damage, or for any damage, including, inter alia, loss of profits, savings, data, loss of benefits, claims by third parties and any property damage or personal injuries arising from or related to the use of the Device.

14. The guarantee shall not cover:

- mechanical damage (cracks, fractures, cuts, abrasions, physical deformations caused by impact, falling or dropping the device or other object, improper use or not observing the operating manual);
- damage resulting from external causes, e.g.: flood, storm, fire, lightning, natural disasters, earthquakes, war, civil disturbance, force majeure, unforeseen accidents, theft, water damage, liquid leakage, battery spill, weather conditions, sunlight, sand, moisture, high or low temperature, air pollution;
- damage caused by malfunctioning software, attack of a computer virus, or by failure to update the software as recommended by the Manufacturer;
- damage resulting from: surges in power supply and/or telecommunication network, improper connection to the grid in a manner inconsistent with the operating manual, or from connecting other devices not recommended by the Manufacturer.
- damage caused by operating or storing the device in extremely adverse conditions, i.e. high humidity, dust, too low (freezing) or too high ambient temperature. Detailed permissible conditions for operating the Device are defined in the operating manual;
- damage caused by using accessories not recommended by the Manufacturer
- damage caused by faulty electrical installation of the Customer, including the use of incorrect fuses;
- damage caused by Customer's failure to provide maintenance and servicing activities defined in the operating manual;
- damage resulting from the use of spurious spare parts or accessories improper for given model, repairing and introducing alterations by unauthorized persons;
- defects caused by operating faulty Device or accessories.

15. The scope of the guarantee repairs shall not include periodic maintenance and inspections, in particular cleaning, adjustments, operational checks, correction of errors or parameter programming and other activities that should be performed by the user (Buyer). The guarantee shall not cover natural wear and tear of the Device and its components listed in the operating manual and in technical documentation as such elements have a defined operational life.

16. If a defect is not covered by the guarantee, the Manufacturer reserves the right to remove such defect at its sole discretion, repairing the damaged or destroyed parts or providing components necessary for repair or replacement.

17. This guarantee shall not exclude, limit or suspend the Customer rights when the provided product is inconsistent with the purchase agreement.

This device complies with Part 15 of the FCC Rules

Operation is subject to the following two conditions:

1. This device may not cause harmful interference
2. This device must accept any interference received, including interference that may cause undesired operation. This equipment has been tested and found to comply with the limits for a Class B digital device, pursuant to part 15 of the FCC Rules. These limits are designed to provide reasonable protection against harmful interference in a residential installation. This equipment generates, uses and can radiate radio frequency energy and, if not installed and used in accordance with the instructions, may cause harmful interference to radio communications. However, there is no guarantee that interference will not occur in a particular installation. If this equipment does cause harmful interference to radio or television reception, which can be determined by turning the equipment off and on, the user is encouraged to try to correct the interference by one or more of the following measures:
 - Reorient or relocate the receiving antenna.
 - Increase the separation between the equipment and receiver.
 - Connect the equipment into an outlet on a circuit different from that to which the receiver is connected.
 - Consult the dealer or an experienced radio/TV technician for help.

Industry Canada (IC) Compliance Notice

This device complies with Industry Canada license-exempt RSSs. Operation is subject to the following two conditions: (1) this device may not cause interference, and (2) this device must accept any interference, including interference that may cause undesired operation of the device.

Cet appareil est conforme aux normes d'exemption de licence RSS d'Industry Canada. Son fonctionnement est soumis aux deux conditions suivantes : (1) cet appareil ne doit pas causer d'interférence et (2) cet appareil doit accepter toute interférence, notamment les interférences qui peuvent affecter son fonctionnement.

Note

Changes and modifications not expressly approved by the manufacturer or registrant of this equipment can void your authority to operate this equipment under Federal Communications Commission's rules.

 **This Device may be used with all devices certified with Z-Wave certificate and should be compatible with such devices produced by other manufacturers.**
Any device compatible with Z-Wave may be added to Fibaro system.

 **FIBAR GROUP FIBARO**
In case of any technical questions contact customer service centre in your country.
www.fibaro.com

 **Information according REACH**
The included Panasonic CR123A battery contains 1,2-Dimethoxyethane substance. Normal use of the device does not expose the user to a given substance.

	Fibar Group S.A. ul. Lotnicza 1, 60-421 Poznań
	CERTIFICATE 1438-CPR-0403 Notified certifying body No 1438 Smoke alarm device FGSD-002 European harmonised standard EN 14604:2005/AC:2008 Declaration of performance No DWU001/015/FG/15